

Fan Coil Unit

Operation and Installation Manual



Table of Contents

1. Introduction	3
2. Remote controller	4
3. Wired wall pad (optional)	6
4. Installation	11
5. Lamp and receiver board	14
6. Wiring diagram	15
7. Dimension drawing	16

INTRODUCTION

The **4-way cassette fan coils** are terminals of a hydronic system for installation in false ceilings. They can be used with chilled and/or hot water to form an air conditioning system.

Unit composition

Cassette panel assembly
aesthetic design, in ABS material with high mechanical characteristics and resistance to ageing.

Unit body of casing
made of galvanized steel sheet metal.

Air passage
pre-formed expanded polystyrene air passage, suitable shaped inside of unit body to allow passage of air, thickness enough for thermal and acoustical insulation.

Heat exchanger
made from copper tubes and aluminium fins with high heat exchange efficiency, with water inlet & outlet connections.

Condensate recovery tray
high density drain pan fitted inside of unit body under the heat exchanger to collect the condensate water.

Condensate pump assembly
the drain pump, no return valve, drainage pipe are fixed inside of the unit. The float switch is connected with the electronic board to control the condensate and alarm level.

Fan motor assembly
the centrifugal balanced fan blower, fitted with the electric fan motor for silent operation.

Electrical control box
contains the electronic control board, wiring terminal, etc.

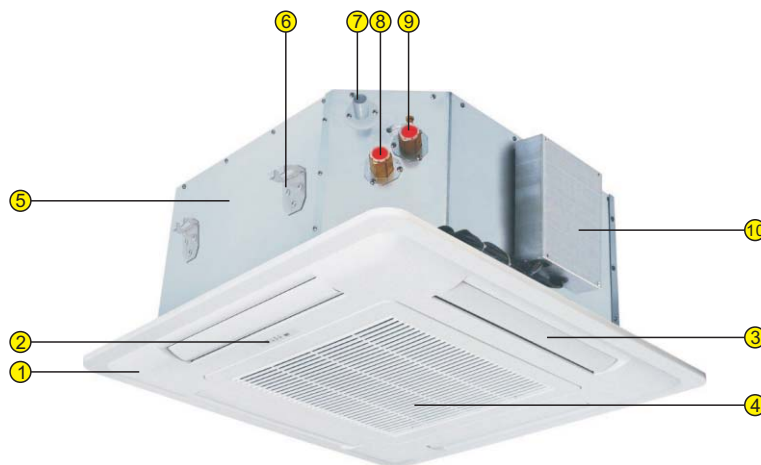

UNIT OVERVIEW

- | | |
|--------------------------|--------------------------------|
| 1. Unit panel | 6. Mounting bracket |
| 2. Lamp & receiver board | 7. Condensate water drain pipe |
| 3. Air discharge louver | 8. Water inlet pipe |
| 4. Air return grille | 9. Water outlet pipe |
| 5. Unit body | 10. Control box |

REMOTE CONTROLLER

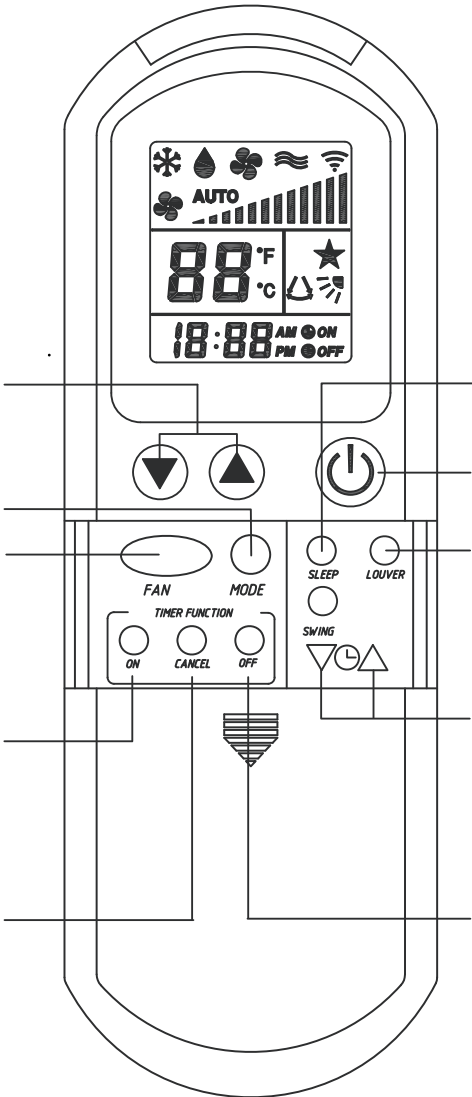

Adjust Set Temperature
 Press down or up button to decrease or increase the desired room temperature.
 * Temperature can not set in Fan mode.

Mode
 Press to select operation mode: Cool-Dry-Fan-Heat-Auto
 * Auto mode for 4 pipe unit only.

Fan
 Press to select the fan speed: Auto-Low-Medium-High
 * Under Fan mode, only low, medium and high are available.
 * Under Dry mode, fan speed will be inhibited and will not be displayed.

On Timer
 First press shows the last timer setting. Subsequent pressing will change the timer setting in 1 minute intervals. Hold down the On button continuously to increase the updating speed.

Cancel Timer
 Press to cancel all timer settings.

Sleep
 Press to activate Sleep function which automatically adjusts the temperature to provide a more comfortable sleep.

On/Off
 Press to switch on or off the unit.

Louver
 Press to change louver angle to a fixed position 1,2,3,4, auto swing or stop.

Clock
 Press down or up button for 2 seconds to activate. The current clock setting will decrease or increase at 1 minute intervals on one press. The speed of interval updating increase after 4 seconds of continuous key press. It will update at high speed after 6 seconds of continuous key press.

Off Timer
 First press shows the last timer setting. Subsequent pressing will change the timer setting in 1 minute intervals. Hold down the Off button continuously to increase the updating speed.

Press the temp. set down ▼ and up ▲ button at same time, to shift the temperature display under °F or °C

1. LCD display area of the wireless remote controller

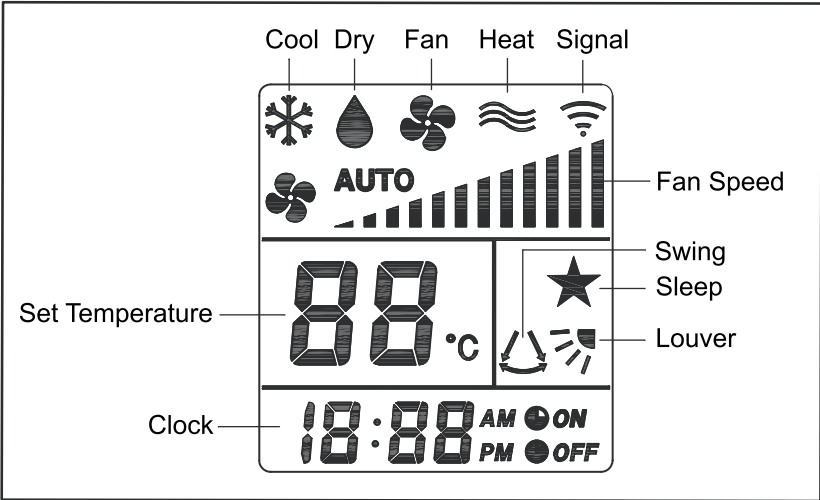

2. Remote controller battery installation

- a. The remote controller use two AAA 1.5V batteries.
- b. Follow below steps to install or replace the battery.
- c. Remove batteries if not used for long period.

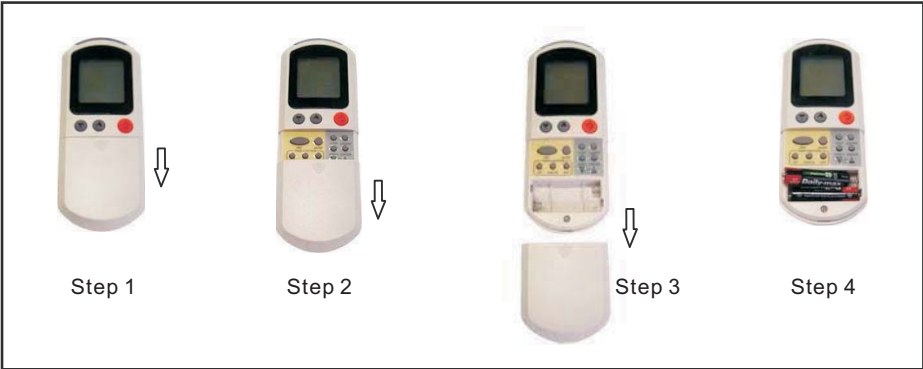

3. Wall holder of remote controller

- a. Fix the wall holder on the wall with 2 screws.
- b. Insert the remote controller into wall holder.

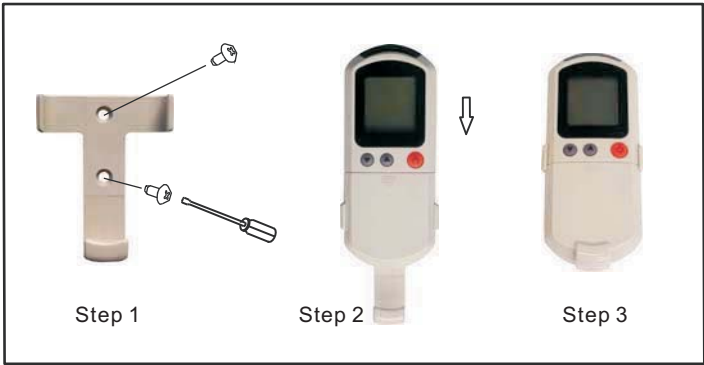

WIRED WALL PAD(OPTIONAL)

● **LCD DISPLAY AREA**

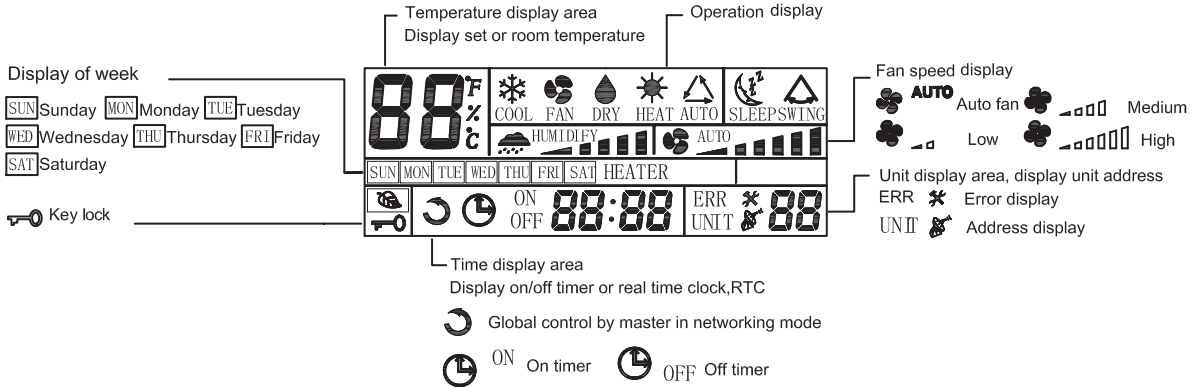

● **WALL PAD BUTTONS**

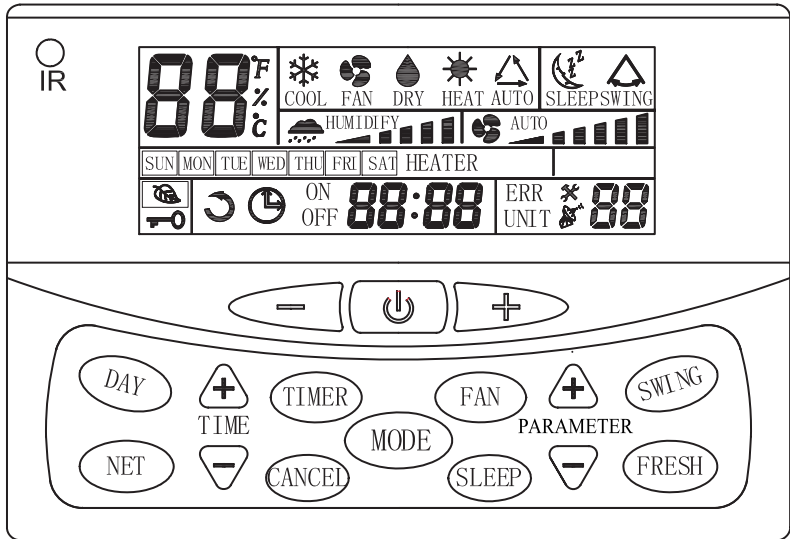

● **IR Infra red reception**



- On/off button, press once to start operation. Press again to stop operation.
- & Room temperature setting button
- Press to select day of week, Sunday to Saturday. Or used in weekly on/off timer programming to select day of week.
- button for networking control
- or to adjust the real time clock setting or to be used in timer ON/OFF programming to adjust timer setting.
- Press to activate on/off timer programming mode
- Press to cancel on/off timer setting in timer programming mode.

- Press to select cool, fan, dry, heat or auto-cool-heat operation mode. (Auto mode for 4 pipe system only)
- Press to select low medium or high speed.
- Press once to select sleep mode. Press again to cancel sleep mode.
- & buttons to browse various parameters.
- Press to activate or deactivate swing function.
- Hold down and buttons for 3 sec to enter into global control mode

WALL PAD OPERATION

1) Clock display and setting

System has an accurate internal real time clock (RTC) used for time indication and timer ON/OFF function.













Normally, real time clock display area indicates internal time clock which can be set by  or  button.

2) Day display and setting













The wall pad support day display function, it can be used as day indication and timer ON/OFF function, day display icon indicates current day. Press  button to set day.

3) Timer ON/OFF setting

If master unit is in global control mode and on/off timer setting is reached, master unit will command the whole network to be on or off. Otherwise timer on/off is effective to the local unit only. The system supports 7 days on/off timer setting.

- a) Press  button once,  and **ON** symbol blinking indicates on timer programming mode, day display area indicates the day for setting timer on. If on timer for this day is null, timer display area shows , otherwise the on timer setting will be shown. Press  or  button to change the on timer setting. Press  key to cancel the current on timer selected and the timer display area shows . Press  button to change the day the on timer to be programmed.
- b) Press  button again,  and **OFF** symbol blinking indicates off timer programming mode. The setting method is the same as on timer setting above.
- c) Press  button again, to exit timer on/off setting function.
- d) Should there be any on or off timer being programmed,  will light up. Should there be any unexecuted on or off timer for the current day, its corresponding **ON** or **OFF** icon will light up.
- e) Hold down  button for 3 sec will cancel all timer settings.

Timer set by master unit are as follow:-



- 1. Press  button to enter into networking control mode. Unit area blinking indicates the slave unit under control. Press  or  to select the desired slave unit. Units that offline will be skipped automatically.
- 2. Press  button once to enter into on timer programming mode. Press  button to select the require day of week. Master unit will then retrieve the setting from the selected slave unit and timer display area will show 'rEAd'. The on timer setting will be shown upon reading the data successfully. Press  or  button to change the on timer setting.
- 3. Press  button again to enter into off timer programming mode. Press  button to select the required day of week. Master unit will then retrieve the setting from the selected slave unit and timer display area will show 'rEAd'. The off timer setting will be shown upon reading the data successfully. Press  or  button to change the off timer setting.
- 4. Upon completion of changing timer settings of the selected day, press  button again to exit timer programming mode. The settings will then update to the selected slave unit. The next day of

the week settings can be done only upon completion of sending data to the salve unit. (Repeat steps 1~4 if setting is required for the next day of week).





5. In Global control mode:

- Pressing master  button for 3sec will cancel all the timer settings in all slave units.
- Timer settings will broadcast to all slave units.

Clock synchronization by master unit is as follow:

1. Press  and  buttons for 3sec to activate clock synchronization to all salve units.
2. Master wall pad responses with a beeping sound.

4) Key lock

In order to prevent unauthorized access to the system setting, a key lock function is provided to prevent mischief. Hold down  and  for 3 sec to activate key lock,  symbol lights up. Repeat the same to exit key lock. Only  button is applicable in key lock mode.

5) Swing

Press  to activate or deactivate swing function.

6) Sleep

Press  button to activate or deactivate sleep setting. Sleep is valid in cool or heat mode only.

7) Temperature setting

Press  or  to enter into temperature setting mode, temperature display area blinks the current set temperature. Press the above button to adjust the set temperature.

8) Mode setting

Press  button to change the operation mode.

9) Fan speed setting



Press  button to change the fan speed, only low speed available for dehumidification mode.

10) On/Off control

Press  to start or stop the air conditioner.



11) Networking control (only master unit wall pad can control slave units on the network)

Press  button to enter into networking control mode. Unit area blinking indicates the slave unit under



control. Press  or  to select the desired slave unit. Units that are offline will be skipped automatically.

Press  button again to exit networking control mode.

Parameters that can be controlled are on/off, timer weekly program, set temperature, mode, fan speed, swing and sleep, operation methods are the same as above.

Hold down  and  buttons for 3 sec to enter into Global control mode,  lights up. Repeat the same to exit global control mode. In global control mode, the setting of master unit will broadcast to all the slave units.

12) Parameter browsing

Hold down  and  buttons for 3 sec to enter into parameters browsing mode. Unit display area shows the slave unit under browsing. Slave unit selection method is the same as in networking control above.

Press  or  to browse various parameters as follow:

Wall pad display Temp. area	Wall pad display Time area
C0	Return air temperature display
C1	Indoor coil 1 temp. display
C2	DIP switch setting display
C3	Indoor coil 2 temp. display (for 4 pipe unit)

Press  button to exit.

13) Error indication

When faulty slave unit is detected, unit display area shows the faulty unit address, time area shows the error code and backlight change to red color. Should there be multiple units having problems, they will be shown one after another.

Error code definition:

Error code	Error
E2	Indoor coil sensor 2 faulty (4 pipe unit)
E3	Return air sensor faulty
E4	Indoor coil sensor 1 faulty
E5	Indoor coil low temperature protection
E6	Indoor coil over heat protection
E7	Water pump faulty
E8	Local communication error

For system without master-slave wall pad will indicate unit error codes as above.

WALL PAD INSTALLATIONS

1. There is one 3V button battery supplied together with the wired wall pad.
2. Open the wall pad back cover and install the battery.
3. Pay attention to the battery + and - polar direction.
4. Mount the wall pad back cover to the desired location on the wall.
5. Fix the wall pad body to the back cover.
6. The wall pad is already connected with the communication wire (length 7.5m). Another head of the wire should be connected with main PCB.

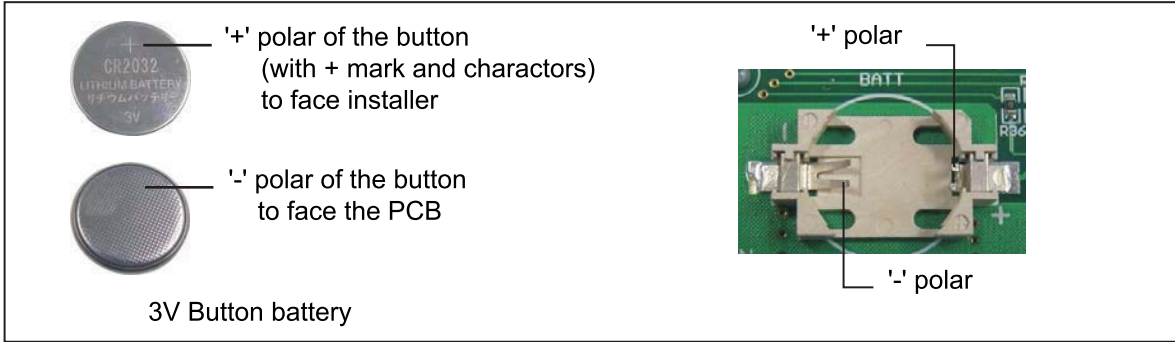
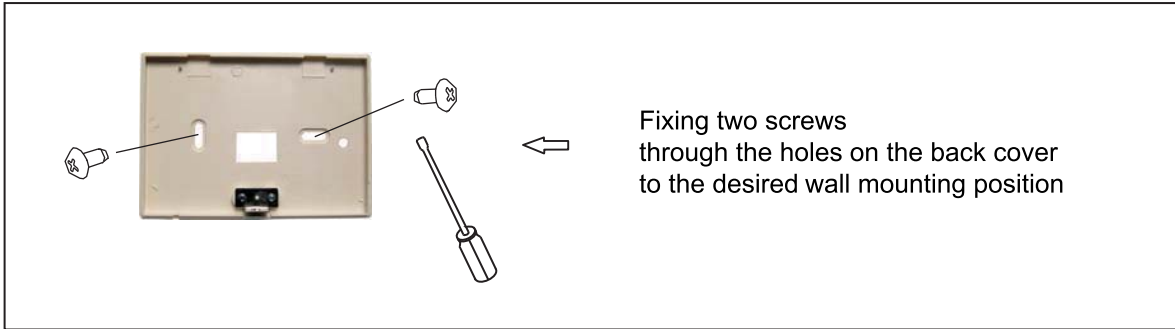
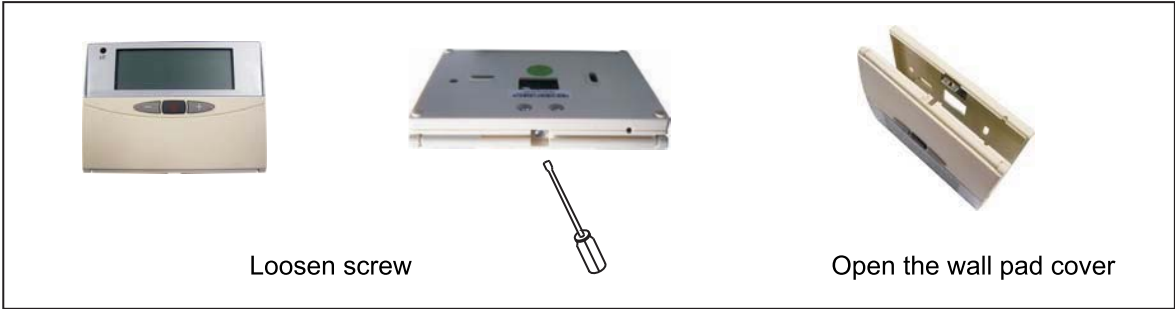



INSTALLATION

1) Package checking

1. Check the package to ensure no damage during transportation.
2. Open the package to check the unit and accessories, record the unit serial number.
3. Attention: to lift the unit by the four corners of unit body. Do not lift unit by the panel, condensate drain pipe or the water connections.

2) Safety cautions

1. The unit should be installed in accordance with national wiring regulation.
2. Before installation, observe cautions in the manual and the labels attached on the unit.

-  Installation & servicing must be carried out by trained and qualified service personnel only!
-  Before carrying out any work, put the proper individual protection devices on.
-  Before carrying out any work, turn off the electric power supply.

3) Operation limits

1. Electric power supply: please refer to the label attached on the unit.
2. Minimum entering water temperature: +2 °C [35.6°F]
3. Maximum entering water temperature: +80 °C [176°F]
4. Maximum height off the ground: 3m

4) Installation location

1. Do not install the unit in rooms where flammable gas or alkaline or acid substance are present (kitchens or workshops etc.). The performance will be affected, and unit components like coils, plastics, etc. will be damaged irreparably.
2. To install unit in the center of room if possible, by using a stacker and inserting a plywood sheet between the unit and the elevated stacker.
3. Be sure the installation location have sufficient strength to carry the weight of the unit. The air inlet grille and air discharge louvers are not obstructed and the treated air is able to blow all over the room.
4. Ensure to have sufficient space for maintenance and servicing operations.

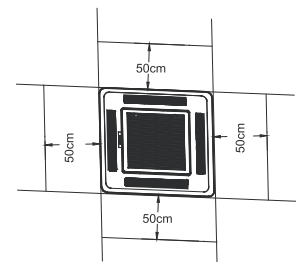
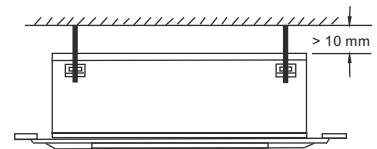

5) Installation to the ceiling

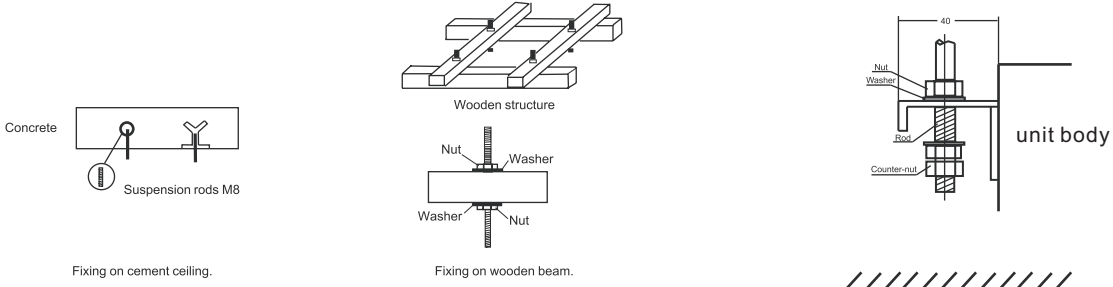

1. To mark the position of suspension rods, water pipes and condensate drain hose, power supply cables, etc.
2. To fix the suspension rods on the cement or wooden ceiling.
3. To lift the unit and fit 4 mounting brackets to the threaded rods. When lifting the unit body into position, take care by its four corners. Do not lift unit by the condensate drain pipe or by the coil connections.
4. Adjust unit position and the distance between the unit body and the lower part of the false ceiling.
5. Ensure the unit is horizontally level, otherwise condensate water can not drain properly. Then, tighten nuts and counter nuts. The rods should have two nuts and washers to lock the unit in position. The mounting brackets will then hook over the washers.
6. After the connection of condensate drainage pipping, inlet and outlet water pipping, to check again and ensure the unit is level.

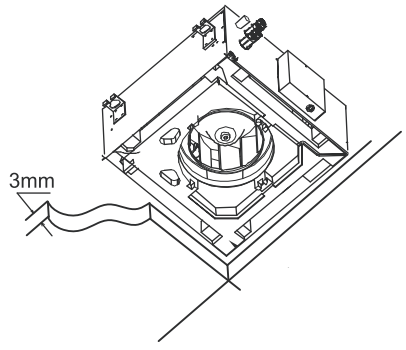
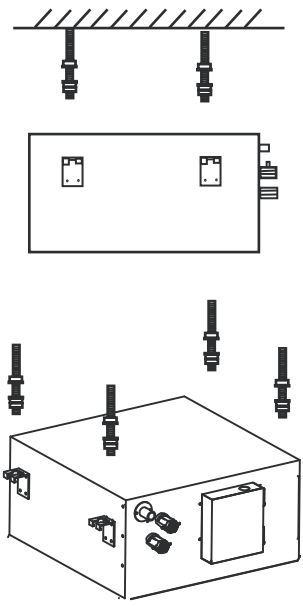

6) Condensate drainage connection

1. The unit is equipped with a condensate drainage pump. The pump allows a maximum 70cm head from the level of the suspended ceiling.
2. The condensate water must be eliminated by linking the proper drainage hose with the drain pipe on the unit body. The drain pipe outer diameter is 1".
3. The installer should connect proper drainage hose with the unit drainage pipe and seal well. The drain must be installed with a downward slope. Downward sloping angle > 1/100.
4. Upon completion, the drainage piping should be insulated. The thickness of pipe insulation should be more than 9 mm.

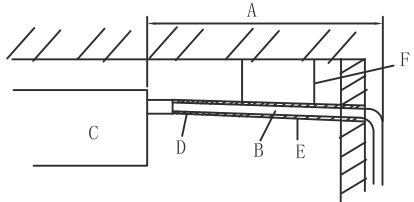

- A. Max. length 20m
- B. drainage hose
- C. unit body
- D. the thickness of pipe insulation > 9mm
- E. downward sloping angle > 1/100
- F. metal hook

7) Water pipe connection

1. To connect and inlet and outlet water pipe properly.
2. To tighten the water connection with two spanners is preferable.
3. Start water inlet supply, turn on the air vent screw on the water inlet pipe to purge out the air inside coil, then close the screw and ensure no leakage of water.
4. After water pipe connection, to insulate the water pipe, connections, valve (if installed), to prevent condensate water.

8) Electrical connection

1. Remove control box cover and refer to the wiring diagram label on the back of the cover.
2. For unit to be installed with valve or without valve, refer to the MAIN PCB configuration in this manual or the notice on wiring diagram label to set PCB respectively.
3. To connect wires properly.
4. After wiring, install control box cover

9) Mounting unit panel

1. Unlock the fasteners on the air return grille. Remove the air return grille from unit panel.
2. Move the unit panel to casing. Tighten 4 screws.
3. Reassemble the air return grille.

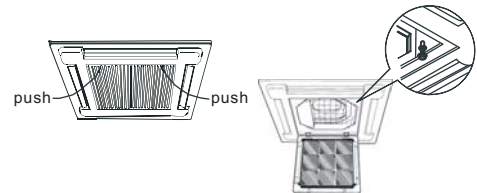

10) Maintenance and service

1. Turn off the main power switch before any operation.
2. Push and unlock the fasteners to open the air return grille.
3. Take out the air filter and wash by water.
4. Check the air filter periodically and before the operating season, to clean or replace while necessary.
5. The service must be carried out by trained and qualified service personnel only!
6. The PCB, transformer, capacitor, terminals are easily accessible by removing the control box cover.
7. The service of internal components, such as coil, fan blower, fan motor involves the removal of the condensate drain pan. During the removal of condensate drain pan, the remained condensate water may be spilled. Please place a plastic sheet under the unit to protect.
8. In the case of service of water coil, please stop the water supply before operation.

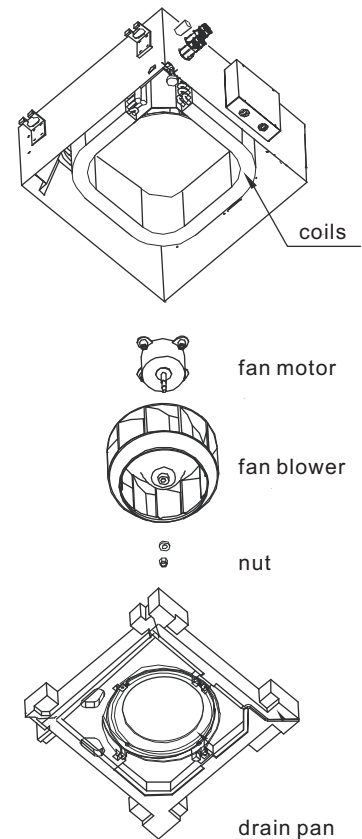

LAMP AND RECEIVER BOARD

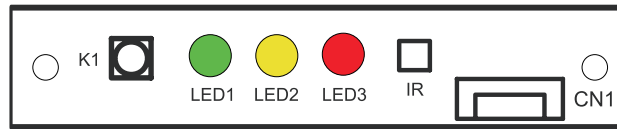

LED3 (RED)	red led lamp on unit under heating operation mode.
LED2 (YELLOW)	yellow led lamp on, Timer on; yellow led lamp off, Timer off;
LED1 (GREEN)	green led lamp on unit under cooling operation mode.
K1 (TOUCH BUTTON)	press to select the operation mode in the sequence of Cool - Heat - Off
IR	IR infrared remote control signal receiver

ERROR CODE DISPLAY

While the GREEN LED lamp flashing, it indicates below error(s):

ERROR(S)	GREEN LED LAMP
Return air sensor failure	Blink 3 times, stop 3 sec
Indoor coil sensor 1 failure	Blink 4 times, stop 3 sec
Indoor coil low temperature protection	Blink 5 times, stop 3 sec
Indoor coil over heat protection	Blink 6 times, stop 3 sec
Water pump failure	Blink 7 times, stop 3 sec

WIRING DIAGRAM

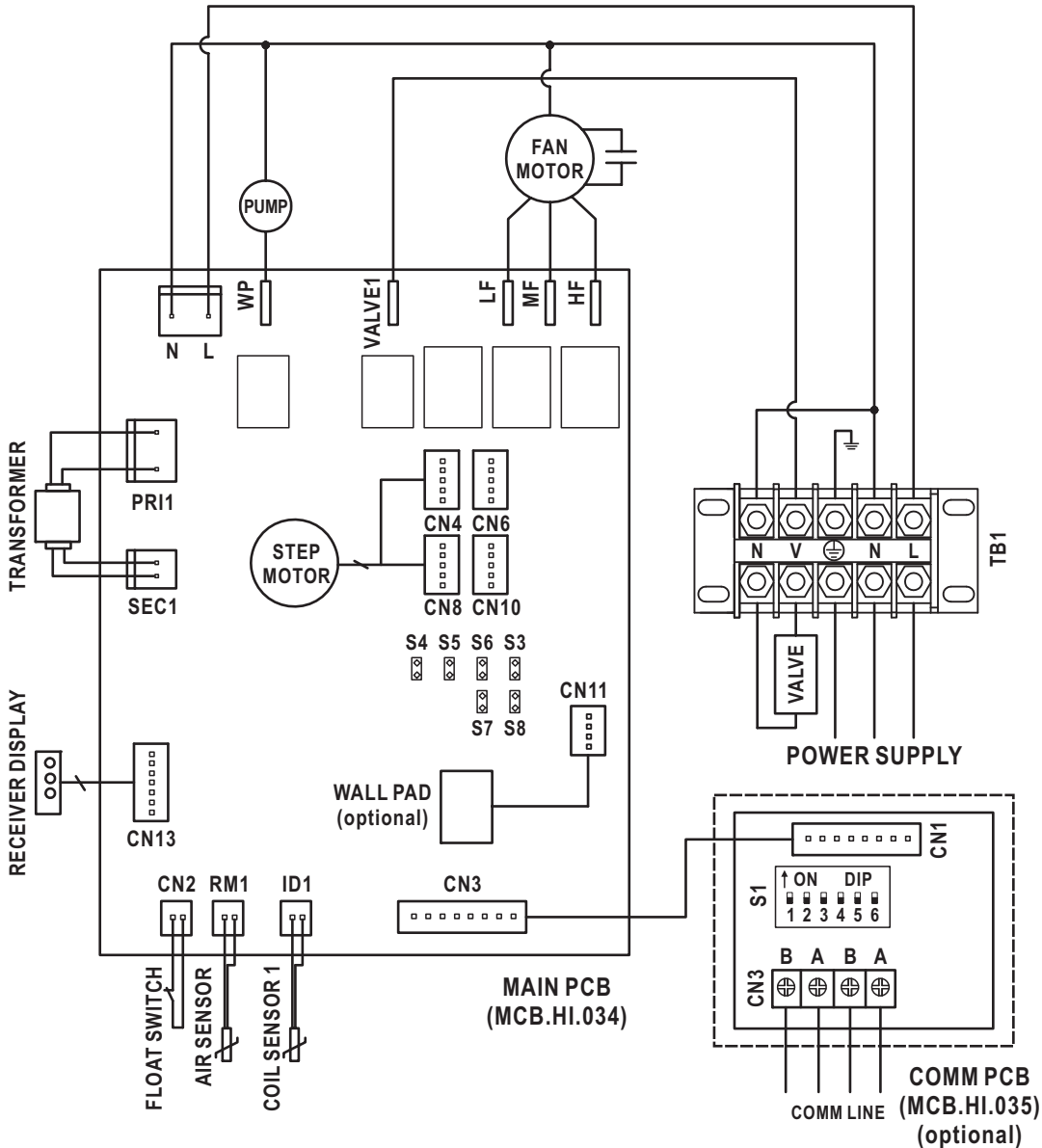

JUMPER S3,S4,S5,S6 CONFIGURATION			LED DISPLAY	
Jumper	Short	Open	LED3 (red)	Heating Mode
S3	Reserved	Louver type for 4-way cassette	LED2 (yellow)	Timer on/off
S4	Reserved	2 pipe unit	LED1 (green)	Cooling Mode
S5	Pre-heat 30 degree	Pre-heat 38 degree	K1 (manual touch button)	Touch sequence: Cool-Heat-Off
S6	With valve	Without valve	IR	IR signal receiver
JUMPER S7-S8 CONFIGURATION			ERROR(S)	GREEN LED LAMP
S7	S8	Model	Return air sensor failure	Blink 3 times, stop 3 sec
Open	Open	Cool-Heat	Coil sensor 1 failure	Blink 4 times, stop 3 sec
Open	Short	Reserved	Coil low temp. protection	Blink 5 times, stop 3 sec
Short	Open	Cool only	Coil over heat protection	Blink 6 times, stop 3 sec
Short	Short	Reserved	Water pump failure	Blink 7 times, stop 3 sec

Wiring Diagram.4-way cassette fan coil unit.2 pipe system

DIMENSION DRAWING

KFA-S

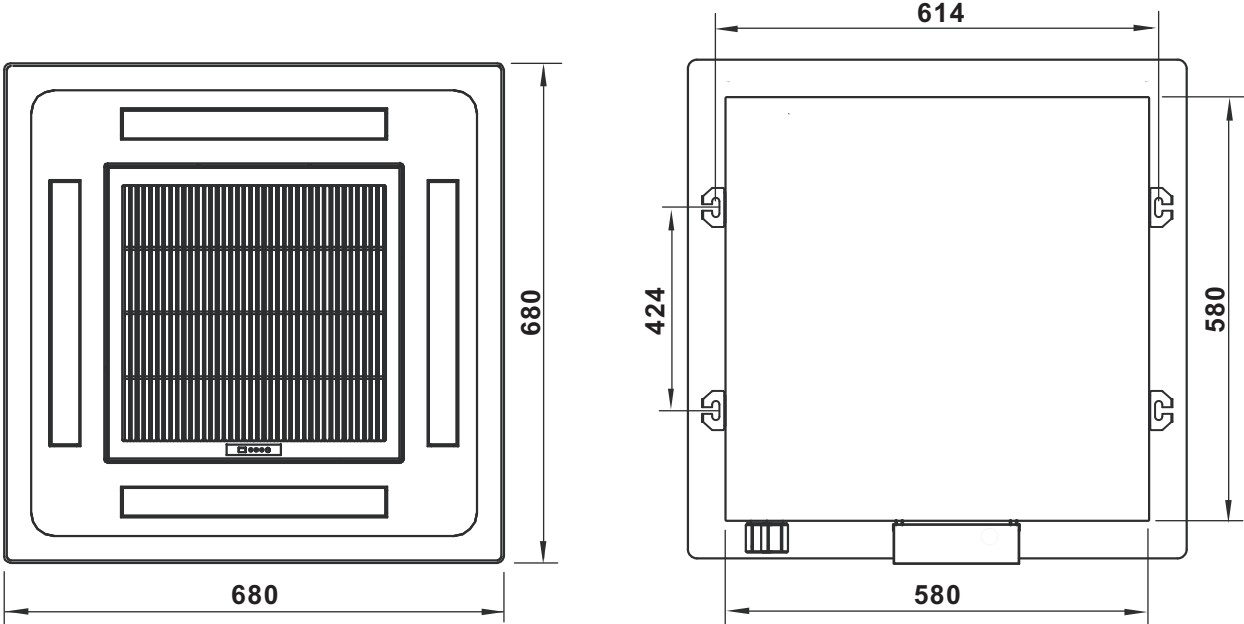

(mm)

DIMENSION DRAWING

KFA-M

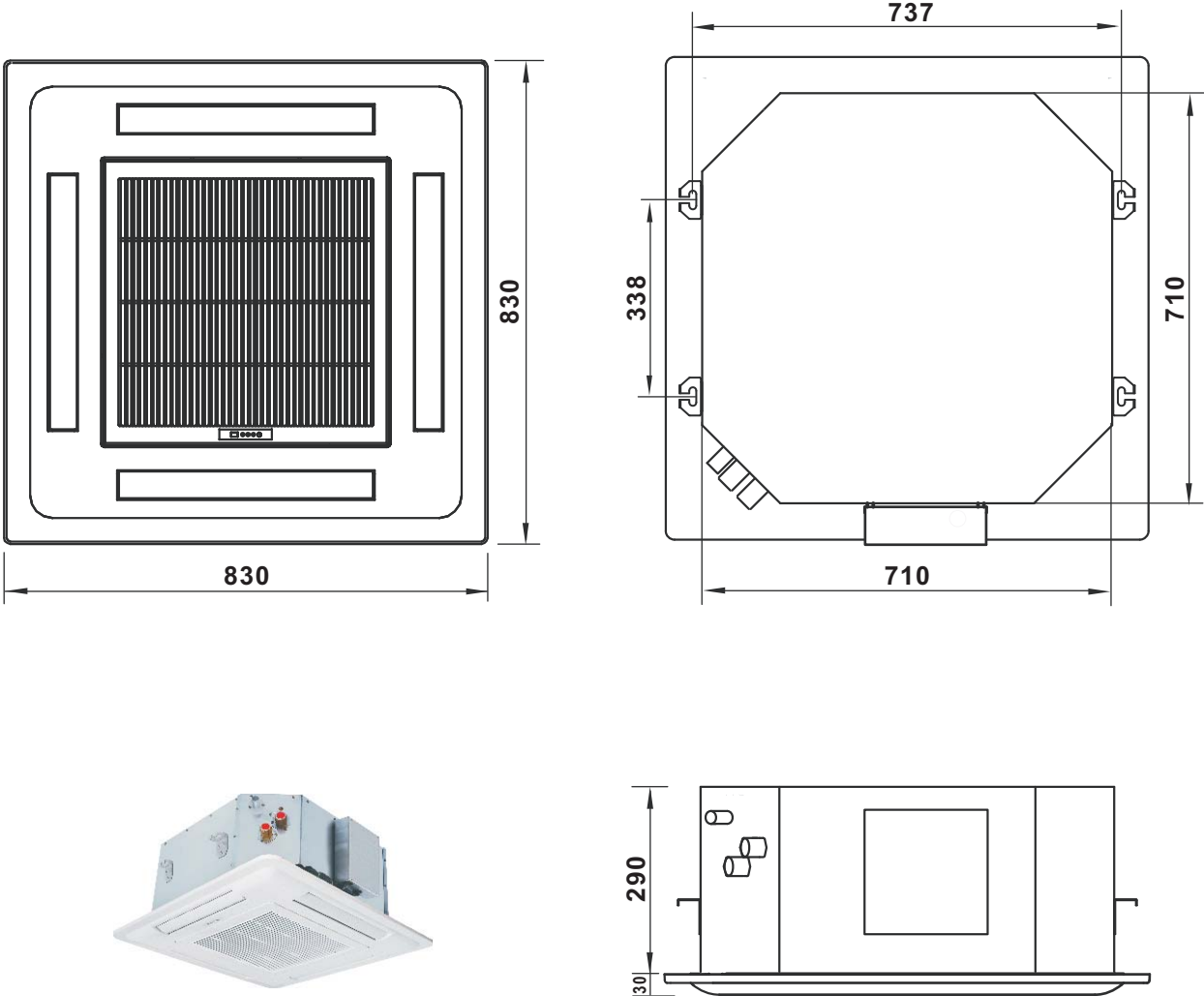

(mm)

NOTE: _____

Technical data shown in this booklet are not binding.
The manufacturer shall have the right to introduce at any time whatever modifications deemed necessary to the improvement of the product.

The name plate, wiring diagram and notice labels on unit take priority to this manual.
